

SteriPEN™ journey^{LCD}

SteriPEN™ Journey^{LCD} User's Guide Instructions for Using Journey^{LCD}

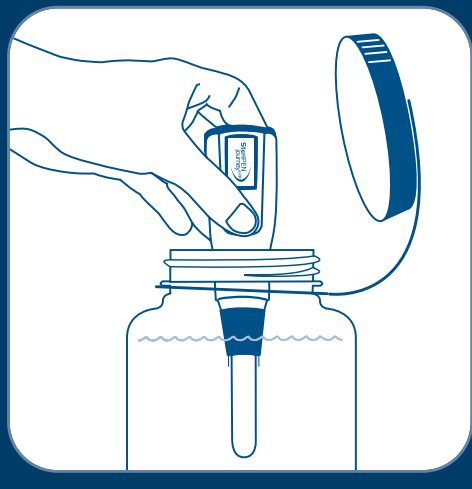

Thank you for buying SteriPEN™ Journey^{LCD}, and congratulations on your purchase. The new LCD (Liquid Crystal Display) screen uses universal symbols, providing the user with added confidence and enhancing ease of use. Years of careful research, development and testing have gone into the creation of this unique product.

Directions for Use 40 C.F.R. §156.10(i)(2)
It is a violation of Federal law to use this product in a manner inconsistent with its labeling.
40 C.F.R. §156.10(i)(2)(ii)

SteriPEN™ exceeds U.S. EPA Guide Standard and Protocol for Testing Microbiological Water Purifiers, destroying over 99.9999% of bacteria, 99.99% of viruses, and 99.9% of protozoa when used as directed. SteriPEN™ is not a sterilizer.

Distributors / Importers

U.S.A.

Hydro-Photon, Inc.
P.O. Box 675
262 Ellsworth Rd.
Blue Hill, Maine 04614 USA
Toll-Free: (888) 783-7473
Tel: (207) 374-5800
Fax: (207) 374-5100
info@steripen.com
www.steripen.com

Australia

Sea To Summit
6 Brown St.
East Perth
Western Australia 6004
Toll Free: (800) 787-677
Tel: +61 8 9221 6617
Fax: +61 8 9221 6618
sales@seatosummit.com.au
www.seatosummit.com.au

Canada

Blue River Trading, Ltd.
16-240 Viceroy Rd.
Concord, Ontario L4K-3N9
Canada
Tel: (905) 738-9401
Fax: (905) 738-8145
info@bluerivertrading.com
www.bluerivertrading.com

Denmark

Army Wear (Retailer)
Hobrovej 825
DK9230 Denmark
Tel: +45 9838 2319
Fax: +45 9838 3219
Aw-service@armywear.dk
www.armywear.dk

Finland

Vandernet Oy
Palkaneentie 19A
00510 Helsinki Finland
Tel: +358-20-741 8333
Fax: +358-20-741 8346
vandernet@vandernet.com
www.vandernet.com

France

Top Rock
RN 532 - N° 11
26300 Pizançon, France
Tél: +33 4 75 02 77 60
Fax: +33 4 75 05 16 42
info@toprock.fr

Hong Kong

Sunmark Camping Equipment Co. (Retailer)
1/FI., 121 Wanchai Rd.
Wanchai, Hong Kong
Tel: +852-2893-8553
Fax: +852-2893-9597
sunmarkhk@hotmail.com

Japan

A & F Corporation
1-1-7, Okubo, Shinjuku-ku
Tokyo 169-0072 Japan
Tel: 81-3-3209-8824
Fax: 81-3-3209-7497
www.aandf.co.jp
info@aandf.co.jp

Nepal

Peak Promotion Trading Pvt. Ltd.
Brahama kumari marga,
House No. 85
Thamel, Kathmandu, Nepal
Tel: 977-1-4249454
Fax: 977-1-4245137
peakgear@mos.com.np

The Netherlands (Holland, Belgium and Luxembourg)

Technolyt
Industrieweg 35
1521NE Wormerveer, Holland
Tel: +31 75-6474547
Fax: +31 75-6213663
info@technolyt.nl
www.technolyt.nl

New Zealand Outfitters

Runciman Road
RD 2, Pukekohe East
New Zealand
Tel: +64 9 238 4571
Fax: +64 9 238 4575
neil@tiroran.co.nz

Saudi Arabia Blue Camp

323 Alkhobar Mall
Alkhobar City, Eastern
Province 31952
Tel: +96 63 8877294
Fax: +96 63 8877295
sales@blue-camp.com
www.blue-camp.com

Singapore

Outdoor Life Pte Ltd
Novena Square
238 Thomson Road #20-60/67
Singapore 307683
Tel: +65 6255-4814
Fax: +65 6255-4816
Info@outdoorlife.com.sg
www.outdoorlife.com.sg

South Africa

Ram Mountaineering
Unit 14 Old Mill Park
Old Mill Way, Ndebeni
Cape Town, South Africa
Tel: +27 21 532 0549
Fax: +27 21 531 2844
info@rammountain.co.za
www.rammountain.co.za

Sweden

Skridskobolaget Devex AB
Fraktflygaregatan 3
SE-128 30 Skarpnäck Swe-
den
Tel: +46 8 683 75 03
Fax: +46 8 683 75 99
skridskobolaget@devex.se

Switzerland, Germany and Austria

Exped AG
Hardstrasse 81
CH-8004 Zurich
Switzerland
Tel: +41 1 497 10 10
Fax: +41 1 497 10 11
info@exped.com
www.exped.com

Turkey

TBS Consultancy Limited
Piyade Sokak 18/10
Cankaya, Ankara, Turkey
Tel: +90 312-442-50-83
Fax: +90 312-440-06-30
stegkil@tbsconsultancy.com.tr

United Kingdom Rosker Ltd.

13 Quay Lane
Gosport
Hampshire, PO12 4LJ
Great Britain
Tel: +44 2392 528711
Fax: +44 2392 529108
sales@rosker.co.uk
www.rosker.co.uk

Duty Free

Sea & Sky Supply
PO Box 3119
3301 DC Dordrecht
Rijksstraatweg 7, 3316 EE
The Netherlands
Tel: +31 78 65 34 580
Fax: +31 78 65 34 581
info@seasky.nl
www.seasky.com

© 2008 Hydro-Photon, Inc.
All rights reserved.
© 2008 Hydro-Photon, Inc.
Alle Rechte vorbehalten.
© 2008 Hydro-Photon, Inc.
Todos los derechos reservados
© 2008 Hydro-Photon, Inc.
Tous droits réservés.

Operating the SteriPEN™ Journey^{LCD}

Quick Start Guide

Use SteriPEN™ Journey^{LCD} with clear water. Discolored or dirty water should be pre-filtered until clear prior to Journey^{LCD} treatment.

SteriPEN™ Journey^{LCD} treats two ranges of water volume:

- A**—up to 0.5 L (16 fl. oz.)
- B**—between 0.5 – 1 L (16 – 32 fl. oz.)

- 

1 Insert 2 CR123 batteries with polarities as shown. *Note: Tighten screw on battery end cap until snug. **Do not over-tighten screw as this may cause damage.***
- 

2 Remove lamp cover. *Note: Sensors must be dry.*
- 

3A Push On/Off button **twice** for up to 0.5 L (16 fl. oz.) – LCD display will show timer ring and 1/2 L treatment volume selected, indicating Journey^{LCD} is ready to use. *Note: On/Off button must be pushed before lamp is immersed in water, or Journey^{LCD} will not function.*
- 

3B Push On/Off button **once** for 0.5 - 1 L (16 - 32 fl. oz.) – LCD display will show timer ring and 1 L treatment volume selected, indicating Journey^{LCD} is ready to use. *Note: On/Off button must be pushed before lamp is immersed in water, or Journey^{LCD} will not function.*
- 



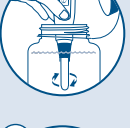

4 While LCD display is on, dip the ultraviolet (UV) lamp into the water to be treated so that lamp and water sensors are completely immersed. When water is detected, lamp turns on automatically, emitting both UV and visible light. When lamp comes on the timer is visible in the upper display. Timer ring fills in as the dose proceeds. Countdown timer is visible inside the ring showing the number of seconds remaining to complete the dose. *Note: If visible light is not evident, the Journey^{LCD} lamp is not on, and water should not be consumed.*
- 



5 During treatment, agitate the water by stirring with the Journey^{LCD} until the lamp automatically turns off. When lamp turns off, LCD displays both Dose Status Successful and Battery Status symbols to show that the UV dose is complete. *Note: If dose fails, see operating symbols and signals below.*
- 



6 Remove the Journey^{LCD} lamp from water. Dry off lamp and water sensors with clean cloth. Replace lamp cover.

SteriPEN™ Journey^{LCD} Display Symbols

Key to Symbols









Volume Selection	
A 	(displayed in lower half of LCD screen)
B 	A: 1 Liter Volume Selected B: 1/2 Liter Volume Selected
Timer Ring	
C 	(displayed in upper half of LCD screen)
D 	C: Dose Time Progressing
E 	D: Dose Status: Successful E: Dose Status: Failed

Battery Symbols	
F 	(displayed in lower half of LCD screen)
G 	F: Good Batteries
H 	G: Weak Batteries H: Failed Batteries





Lamp Symbols	
I 	I: Lamp Life Progress Bar (displayed between upper and lower LCD screens)
J 	J: Lamp Failure (displayed in upper half of LCD screen)

LCD Symbols Operating and Battery Signals

(1 Liter example shown; see above for 1/2 Liter Volume Symbol)

1 	Volume Selection and Dose Activation With Good Batteries. Volume selection visible in lower display. Timer ring visible in upper display.
2 	Volume Selection and Dose Activation With Weak, but Functional Batteries Volume selection alternates with Weak Battery symbol in lower display.
3 	Volume Selection With Failed Batteries Batteries too weak to start purification cycle; volume selection does not display; Failed Batteries symbol flashes in lower display.
4 	Purification Timer Progress (1/2 L dose shown) For both 1/2 Liter and 1 Liter volumes, timer ring in upper display starts out empty and fills with black, in a clockwise direction, as dose time passes.
5 	Dose Complete With Good Batteries Smiling timer visible in upper display; volume selection and Good Battery symbol visible in lower display.
6 	Dose Complete With Weak Batteries Smiling timer visible in upper display; volume selection and Weak Battery symbol visible in lower display.
7 	Dose Incomplete Due To Failed Batteries If dose is ended prematurely due to battery failure, timer ring stops progressing. Dose Status: Failed symbol visible in upper display; Failed Batteries symbol visible in lower display.
8 	Dose Incomplete If sensor pins are removed from water before dose is completed, timer ring stops progressing. Dose Status: Failed symbol flashes in upper display.

LCD Symbols Lamp Signals

9 	Lamp Life Progress Bar As doses are used, the lamp life bar fills in black from left to right reflecting the proportion of doses used verses unused (the unit is programmed for a total of 10,000 doses). Lamp progress bar is not visible while lamp is on.
10 	Lamp Approaching End of Life When the microcontroller has recorded 9,900 lamp cycles, the Lamp Life Progress Bar will blink.
11 	Broken Lamp Lamp Failure symbol visible in upper display; Lamp Life Progress Bar visible.
12 	End of Lamp Life Lamp Failure symbol visible in upper display; Lamp Life Progress Bar filled with black.

Safety

SteriPEN™ Journey^{LCD} may be used in glass, plastic, ceramic or metal containers. They all absorb and reflect UV light, thereby shielding the user from UV exposure. Journey^{LCD} should not be used in quartz containers. The air/water interface at the top of any drinking container is highly reflective to UV and reflects UV back into the container.

Water Sense Circuitry

The Journey^{LCD} water sense circuitry is intended to prevent the UV lamp from illuminating unless it is completely immersed in water. If Journey^{LCD} is not immersed in water within 15 seconds of being activated, it will deactivate.

Agitation of Water

Agitation of the water by stirring with Journey^{LCD} or rocking the container is essential for proper operation as this insures uniform exposure of all water to germicidal UV light.

Cold Weather Considerations

Bring SteriPEN™ Journey^{LCD} up to a temperature above 32°F/0°C before using. Battery performance may be adversely affected by cold weather. NiMH rechargeable batteries are the best choice for economical use as well as for cold weather. Store your batteries in your pocket or warm place when in cold weather conditions.

Battery Selection & Installation

SteriPEN™ Journey^{LCD} uses two CR123 batteries. CR123 batteries are nominally 3 volts and are available in both rechargeable and non-rechargeable (disposable) varieties.

Our testing has shown that a single set of non-rechargeable (disposable) CR123's will treat approximately 50 liters of water. Testing on rechargeable CR123's indicates that approximately 35 liters may be treated between battery charges. For best results, use high-quality batteries.

Cold ambient temperatures may reduce the number of doses available from batteries. To maximize available battery power keep your batteries in a warm place (i.e. your pocket) when in cold weather conditions. To replace batteries, loosen screw in battery end cap with a coin and then remove end cap (see "Operating the SteriPEN™, diagram 1). Install new or recharged batteries with battery polarity as shown. Replace the battery end cap and tighten screw until snug. **Do not over-tighten screw as this may damage the device.** Note that if you will be storing your SteriPEN™ Journey^{LCD} for a long period of time, it is best to remove the batteries from the device.

IMPORTANT NOTE: Many brands of CR123 batteries have built-in protection circuitry that instantly disables battery function when batteries reach a specific low charge threshold. If this "disable" function is triggered during operation the Journey^{LCD} will be unable to display the Weak Batteries signal. Until batteries are replaced or recharged the Journey^{LCD} will not be operational.

Treating Turbid, Murky or Cloudy Water

SteriPEN™ Journey^{LCD} is intended for use, and is most effective, in clear water. However, Journey^{LCD} has been shown to reduce microbial contamination in turbid water. If clear water is not available, first try to filter the water to clarify it. If it is necessary to treat turbid, murky or cloudy water in an emergency situation, use Journey^{LCD} as follows:

- To treat 1 liter of turbid water, use two one-liter treatments. To accomplish this, push the operating button one time and complete the first treatment. Then push the button one time again and complete the second treatment.
- To treat 0.5 liters of turbid water, use a single 1 liter dose. To accomplish this, push the operating button once and complete the treatment.

Turbidity is a measure of water clarity as affected by the presence of suspended solids. As turbidity increases, the suspended solids and murkiness of the water also increase. It is difficult to communicate a particular level of turbidity with just a written description. Accordingly, please take into account the following when considering the use of Journey^{LCD} in water that is not clear: Laboratory testing has shown that Journey^{LCD} is effective in water with a turbidity of not less than 30 ntu (Nephelometric Turbidity Units) as described in the US EPA Guide Standard and Protocol for Testing Microbiological Water Purifiers, section 3.3.4. Journey^{LCD} has been successfully tested in water with a turbidity measurement of 33 ntu. If viewing 33ntu water in a clear 1 liter bottle, one might characterize the water as follows: *Much closer to clear than opaque, Obviously not clear, Obviously cloudy, Objects viewed through the water are visible but blurry, As cloudy as weak lemonade.*

Care and Cleaning

When not in use, SteriPEN™ Journey^{LCD} should be kept in a clean, dry, non-abrasive area or container. Journey^{LCD} should not be exposed to ambient temperatures above 140°F/60°C or below -4°F/-20°C. When storing Journey^{LCD} for long periods, remove batteries.

To clean Journey^{LCD}, wash with a soft cloth and a mild soap solution. Rinse soap from device and dry with a clean, soft cloth. Note that while the battery compartment of Journey^{LCD} is designed to be water resistant, it is not guaranteed to be impermeable and should therefore never be submerged.

Troubleshooting

If the LCD screen indicates SteriPEN™ Journey^{LCD} is ready, but the lamp does not light when immersed in water, check to be sure lamp is completely immersed and that water is contacting both sensors.

If immediately after completing a treatment another treatment is attempted, but LCD screen indicates incomplete dose (see LCD Symbol 8), check to see that the Journey^{LCD} water sensors are not wet. Dry sensors and press On/Off button again.

If fresh batteries have been installed, but Journey^{LCD} will not complete a dose, low temperature may be the cause. NiMH rechargeable batteries are a better choice for cold weather applications.

Repair Information

Any repairs to your SteriPEN™ Journey^{LCD} should be done by an authorized technician. Please contact your local distributor/importer for all repairs.

Product Registration & Warranty Information

Limited Lifetime Warranty for any manufacturing defect. For product registration and complete warranty information, please visit www.steripen.com/warranty or contact your local distributor/importer.

Warnings for Safe Use

- Improper operation of SteriPEN™ Journey^{LCD} may cause injury. Read and understand all warnings prior to operating Journey^{LCD}.
- Do not allow water to enter Journey^{LCD} through the battery compartment.
- Do not submerge the battery compartment end of the device.
- Do not operate Journey^{LCD} in quartz containers such as quartz laboratory beakers.
- Journey^{LCD} is not intended for use by children.
- Journey^{LCD} is a high voltage device. Removal or tampering with the electronic circuit board or lamp assembly may cause injury, or damage Journey^{LCD}.
- Do not open, expose, modify or touch internal circuitry; this can lead to high voltage shock.
- Do not attempt to bypass water sensor; this is an important safety feature.
- As with any water treatment system, you should always have a backup method available.
- Like most fluorescent-type lamps, The Journey^{LCD} lamp contains a small amount of mercury. Please return your Journey^{LCD} at the end of its productive life to your distributor/importer to permit correct recycling or safe disposal.
- Journey^{LCD} is not intended to disinfect surfaces of a drinking container, i.e. those that typically contact the mouth when drinking. Be certain that your drinking container has been properly cleaned/washed prior to using Journey^{LCD}.
- Journey^{LCD} is not intended to disinfect water above the surface of the water in the container, i.e., droplets of water suspended on the side of the glass.
- Journey^{LCD} is intended for use with clear water but in emergencies may be used in moderately turbid water. See "Treating Turbid, Murky or Cloudy Water" section above before deciding to use Journey^{LCD} on turbid water.
- Journey^{LCD} is designed to treat 0.5 or 1.0 liter (16 or 32 fl. oz.) of clear water. If in doubt about volume of water to be treated, confirm volume with a measuring device such as a measuring cup.
- Do not store Journey^{LCD} for long periods with alkaline batteries installed.
- When operating properly, the Journey^{LCD} lamp will emit visible light as well as UV. If lamp is not emitting visible light, it is not functioning properly, and should not be used until repaired.
- The Journey^{LCD} lamp assembly must be clean prior to use.
- If Journey^{LCD} is below 32°F/0°C it should be warmed above 32°F/0°C before operating.
- Do not allow impact to the lamp end. If lamp assembly (lamp or quartz sleeve) is cracked, chipped or damaged, do not operate. Return to your local distributor/importer for repair.
- Do not use as a light source.
- Do not use in liquids other than clear water.
- Do not use in water with ice.
- Do not use in water above 140°F/60°C.
- UV light can be harmful to eyes and skin. Never look at an unshielded UV lamp during operation. When used properly, according to instructions, the user is well shielded from Journey^{LCD} UV light.
- Do not operate near skin.
- Do not operate near eyes.
- Do not insert into bodily orifices.

- While carefully controlled microbiological testing of Journey^{LCD} has been conducted, use of Journey^{LCD} in the field may produce results that vary from our laboratory test data.
- Do not use in any manner other than instructed in this User's Guide.

Certifications & Patents

Compliance testing of SteriPEN™ for the cETLus and CE marks was successfully completed at Intertek Testing Services (ITS), Boxborough, MA, USA. This testing is described in ITS test report number: J20027896.01, October 18, 2000.

Conforms to EN61010-1:1993 + A1 + A2 and EN 61326 Listed 3058969. Conforms to Standard UL 61010A-1 Certified to CAN/CSA Standard C22.2, No. 1010.1-92 U.S.E.P.A. Company #73679, U.S. EPA Establishment #07369-ME-001



SteriPEN™ technology is patented in the USA with further U.S. patents pending and patents pending worldwide. SteriPEN™ is a trademark of Hydro-Photon, Inc. U.S. Patent Numbers 5,900,212 & 6,110,424 & 6,579,495

SteriPEN™ Journey^{LCD} works with the SteriPEN™ Pre-Filter (sold separately). Fits most wide-mouth water bottles.

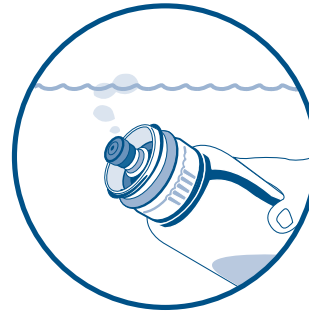
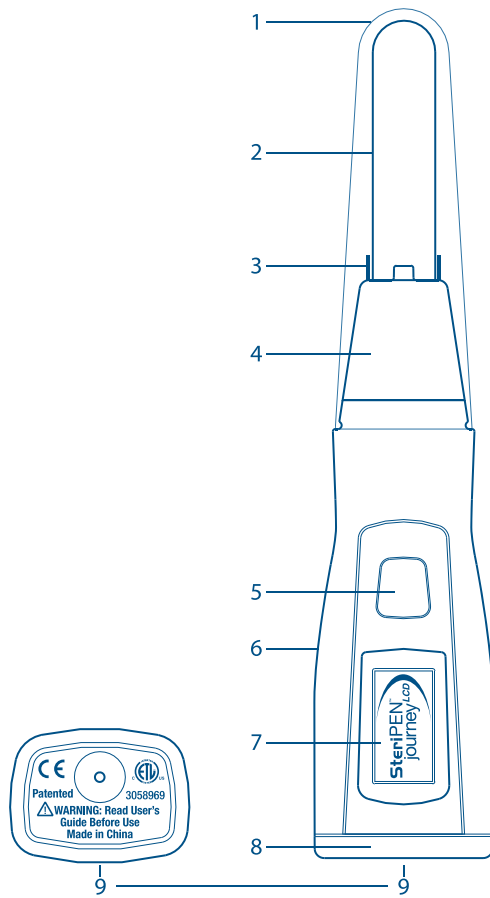

1) Fill Bottle



2) Purify



3) Drink

Guide to SteriPEN™ Journey^{LCD} Parts

- 1) UV Lamp Cover
- 2) UV Lamp Assembly
- 3) Water Sensors (2)
- 4) Rubberized Neck
- 5) On/Off Button
- 6) Thumb Grip (finger grips on opposite side of device)
- 7) Indicator LCD (Liquid Crystal Display):
Displays Operating, Battery, and Lamp Signals
- 8) Battery Compartment End Cap
- 9) Warning Label

Did you know?

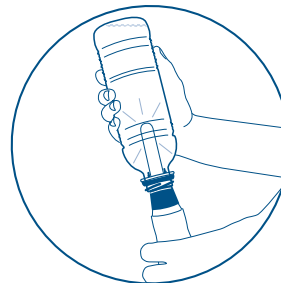

You can use your SteriPEN™ Journey^{LCD} with pre-filled water bottles up to 1 liter in size.

Using Journey^{LCD} instead of buying bottled water keeps plastic bottles out of landfills.

Hydro-Photon, Inc.
P.O. Box 675
262 Ellsworth Rd.
Blue Hill, ME 04614 USA
Tel: (207) 374-5800
Fax: (207) 374-5100
info@steripen.com

www.steripen.com

MANJY0712